

Transportation Workbook

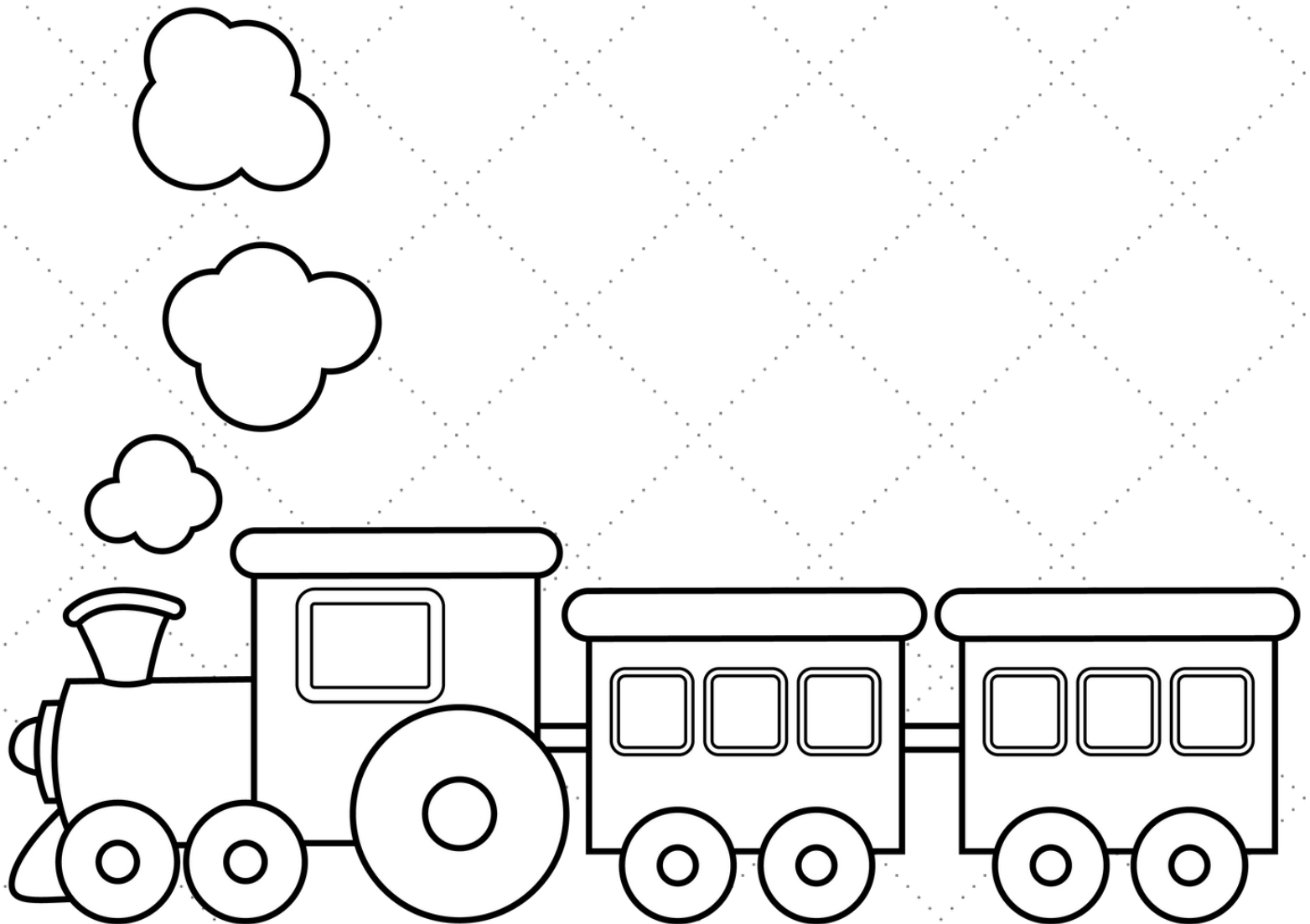

Match the uppercase letters to the lowercase letters.

A

B

C

D

E

F

G

H

d

c

b

a

f

e

h

g

Match the uppercase letters to the lowercase letters.

I
J
K
L
M
N
O
P
Q

q
p
o
j
i
m
l
n
k

Match the uppercase letters to the lowercase letters.

R

S

T

U

V

W

X

Y

Z

w

z

r

t

u

v

x

s

y

Draw a line from the number to the matching word.

6

one

4

two

5

three

3

four

2

five

8

six

9

seven

10

eight

1

nine

7

ten

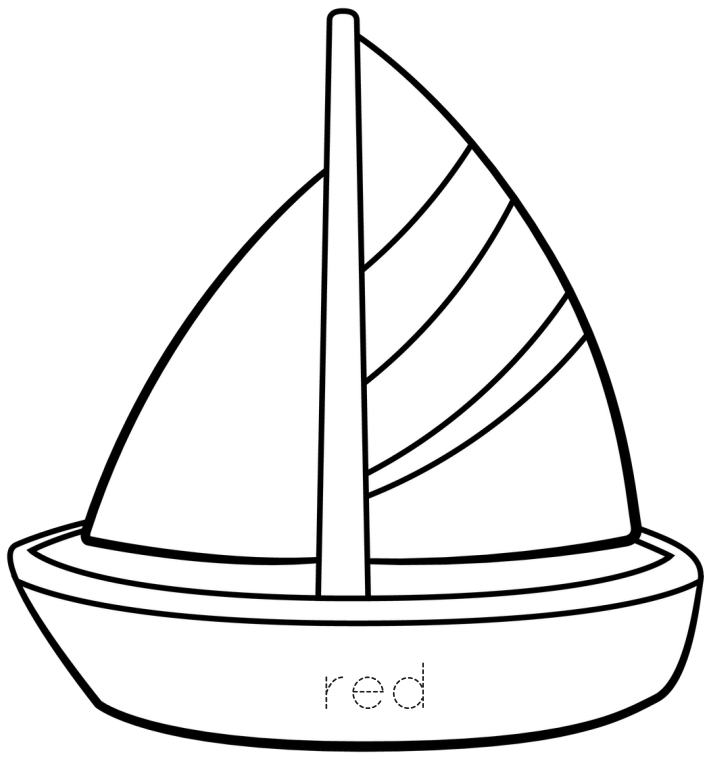

red

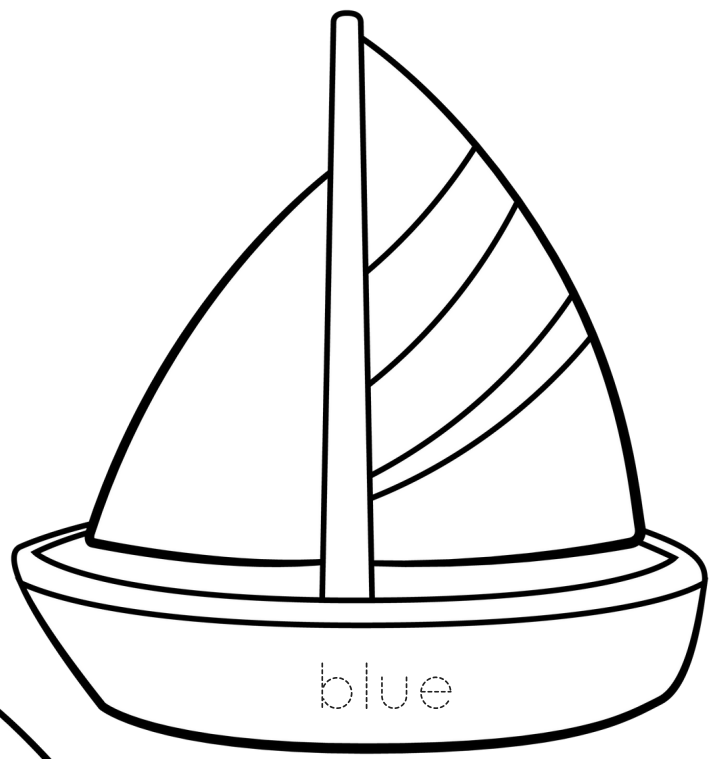

blue

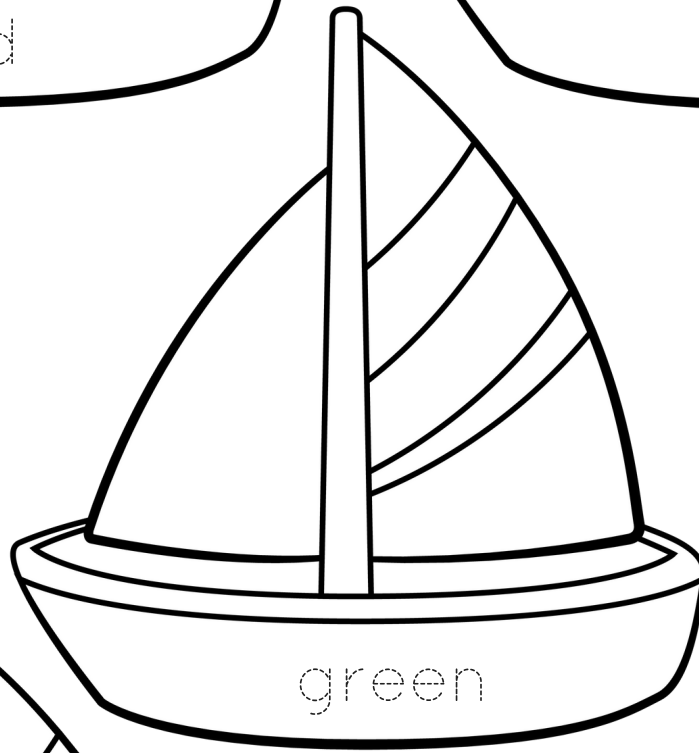

green

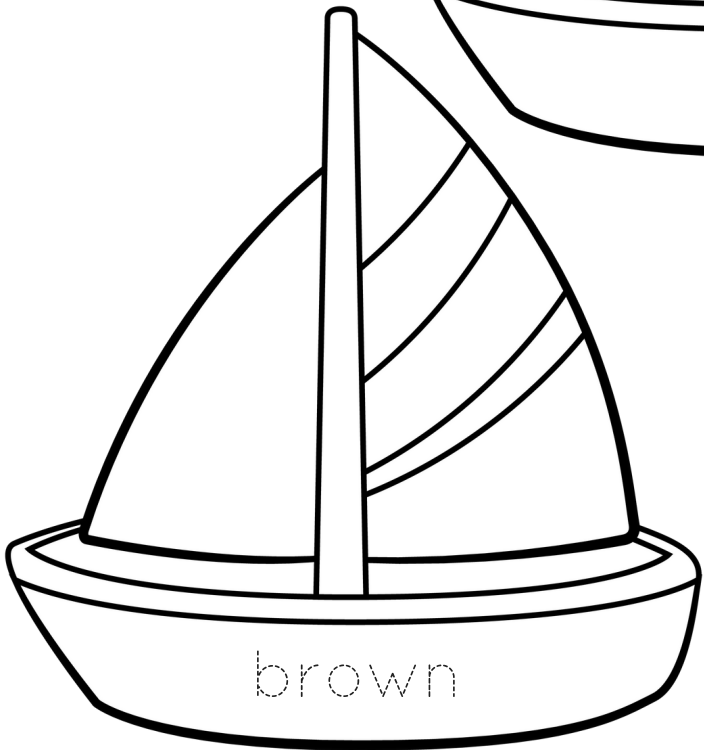

brown

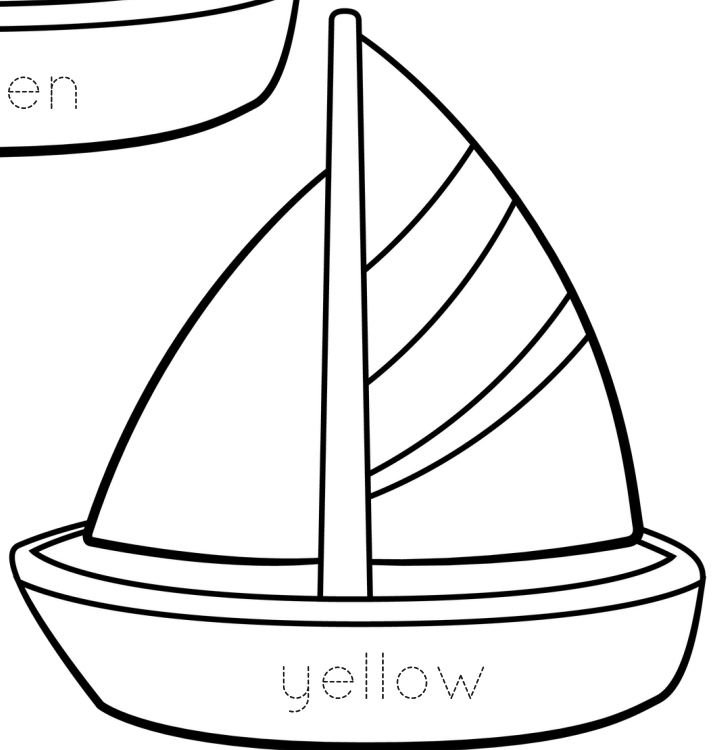

yellow

Write the number in each box.

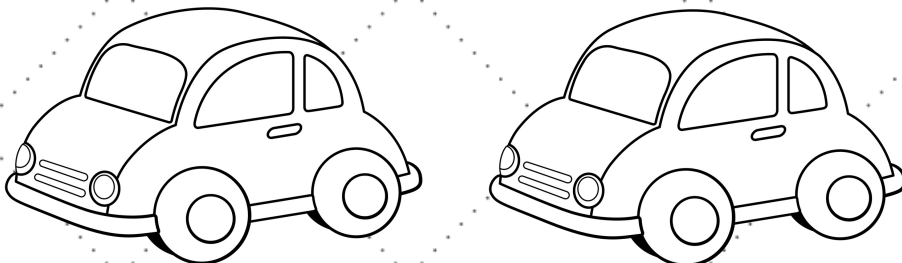
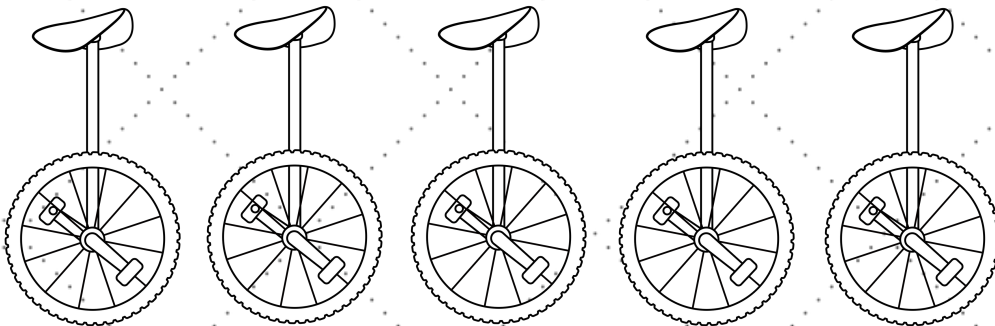
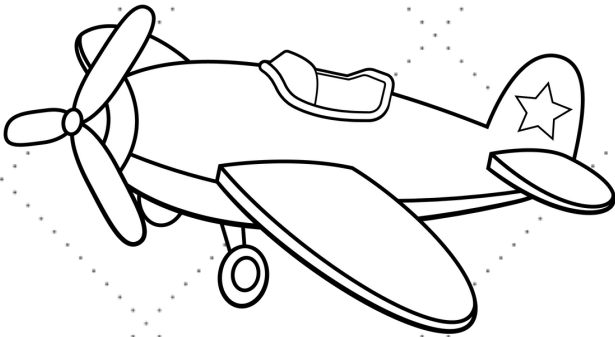
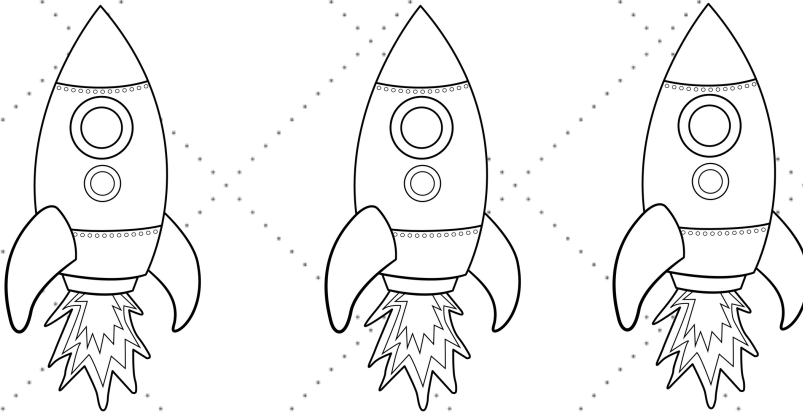
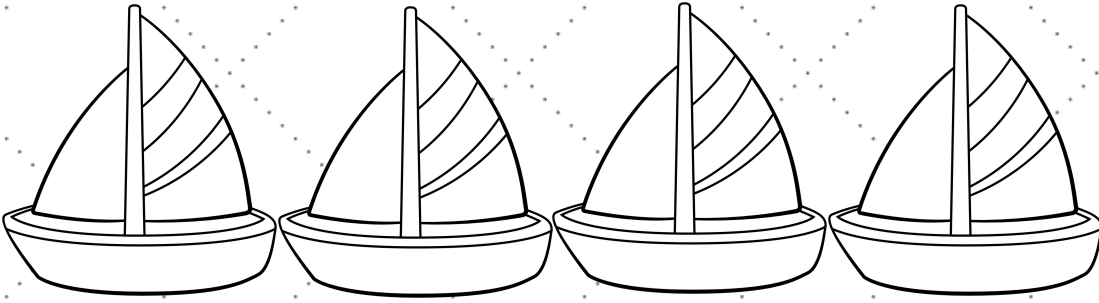

Color the dump truck.

1 - blue

2 - red

3 - green

4 - black

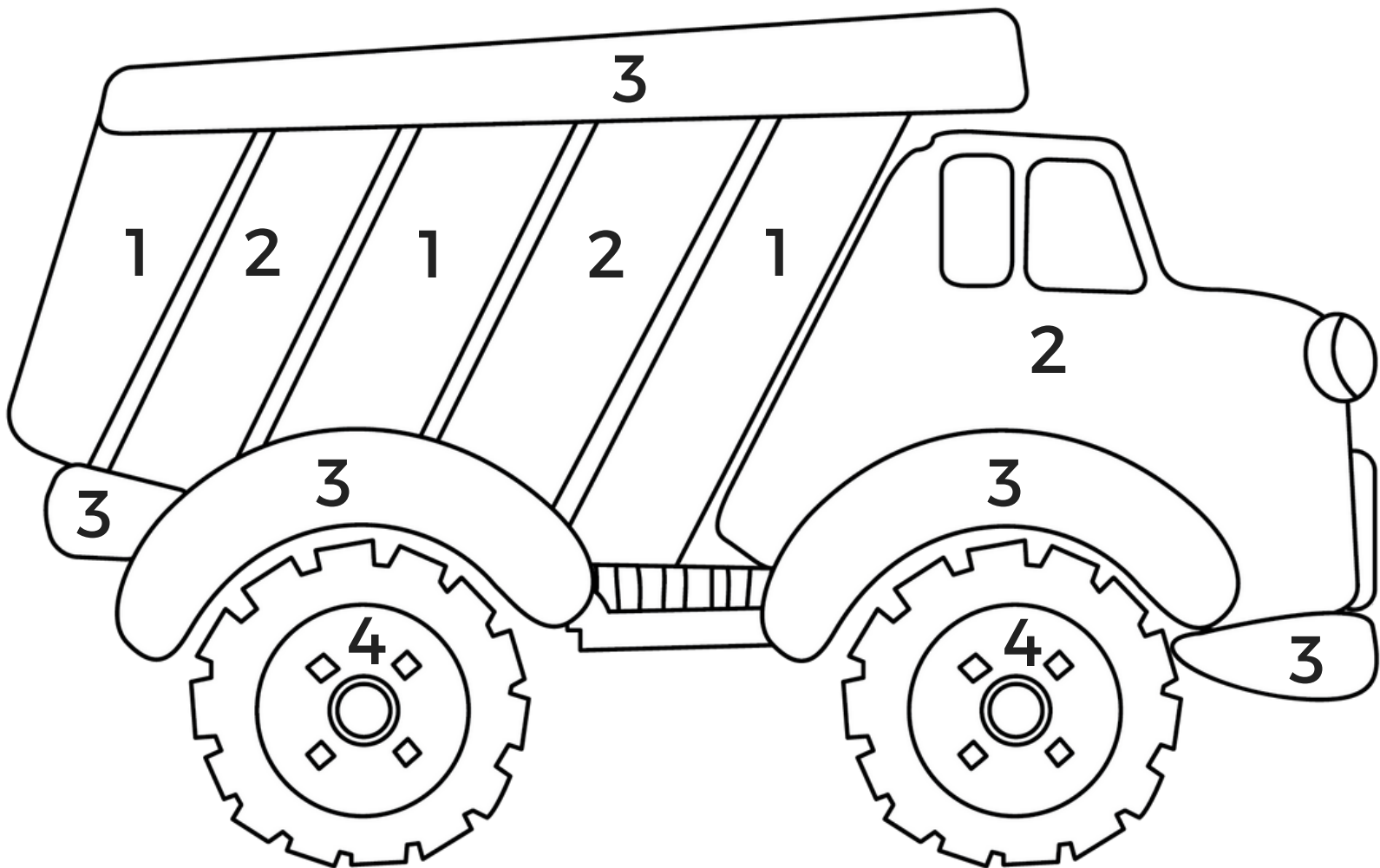

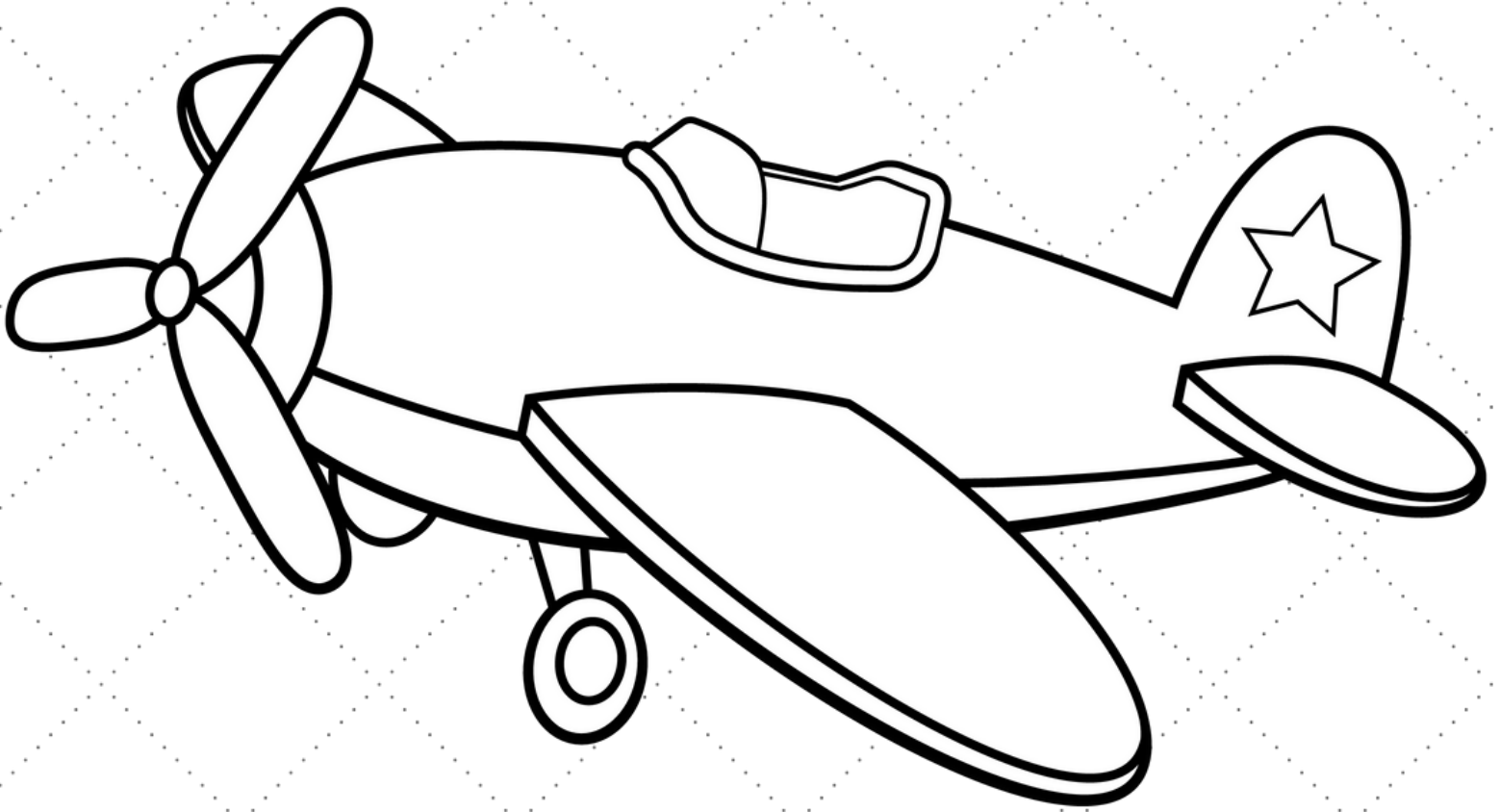

A

is for _____.

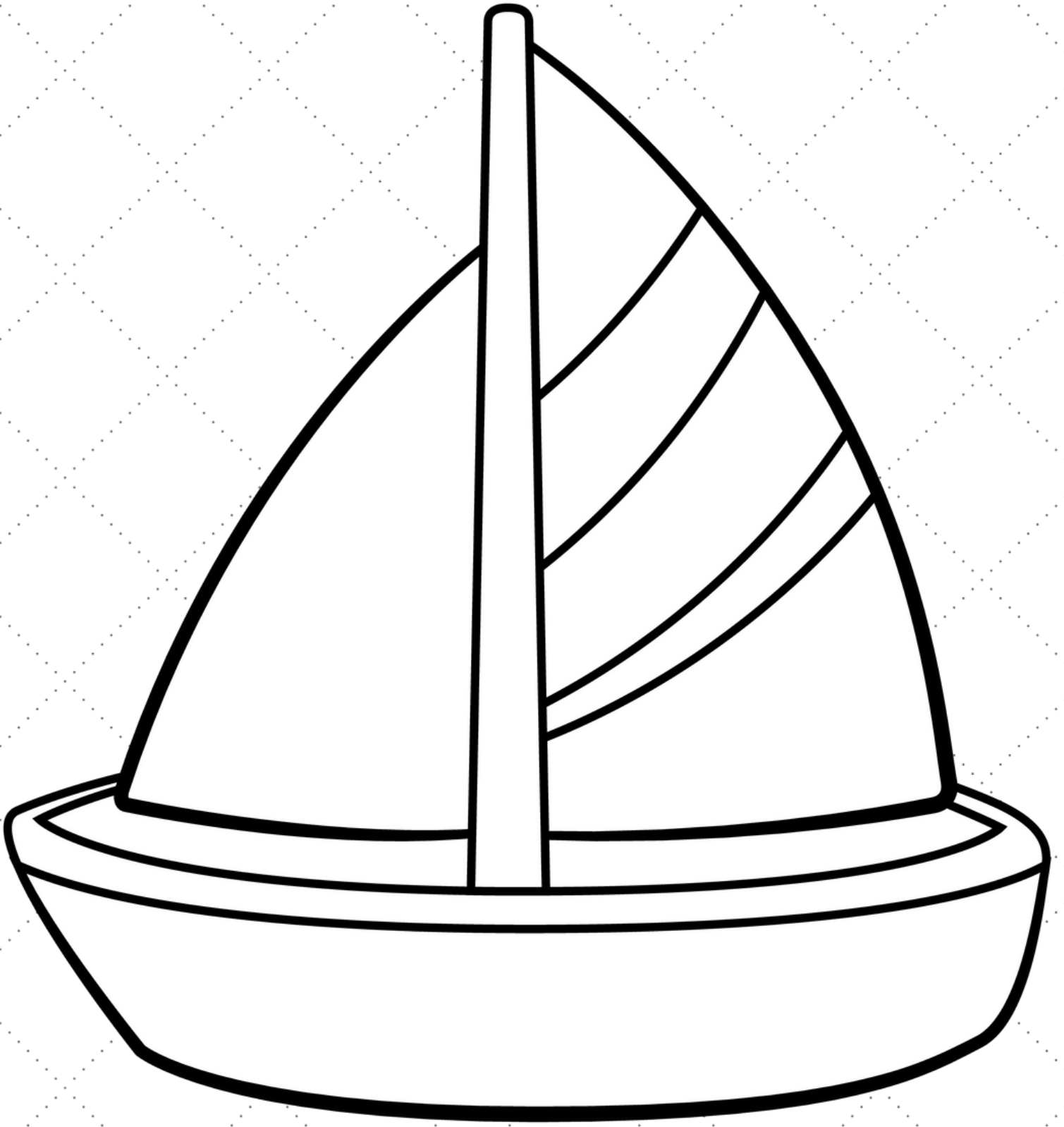

B

is for _____.

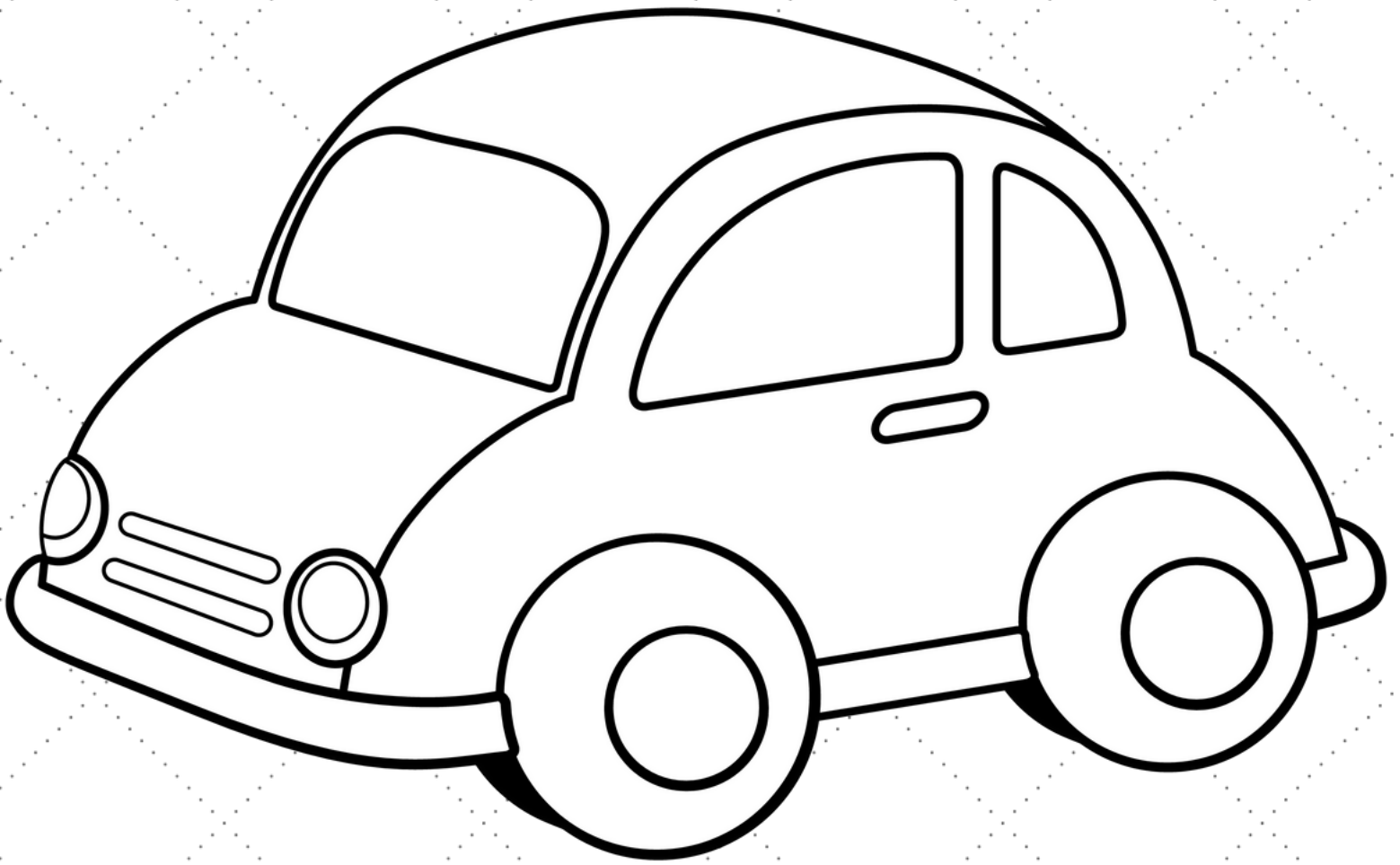

C

is for _____.

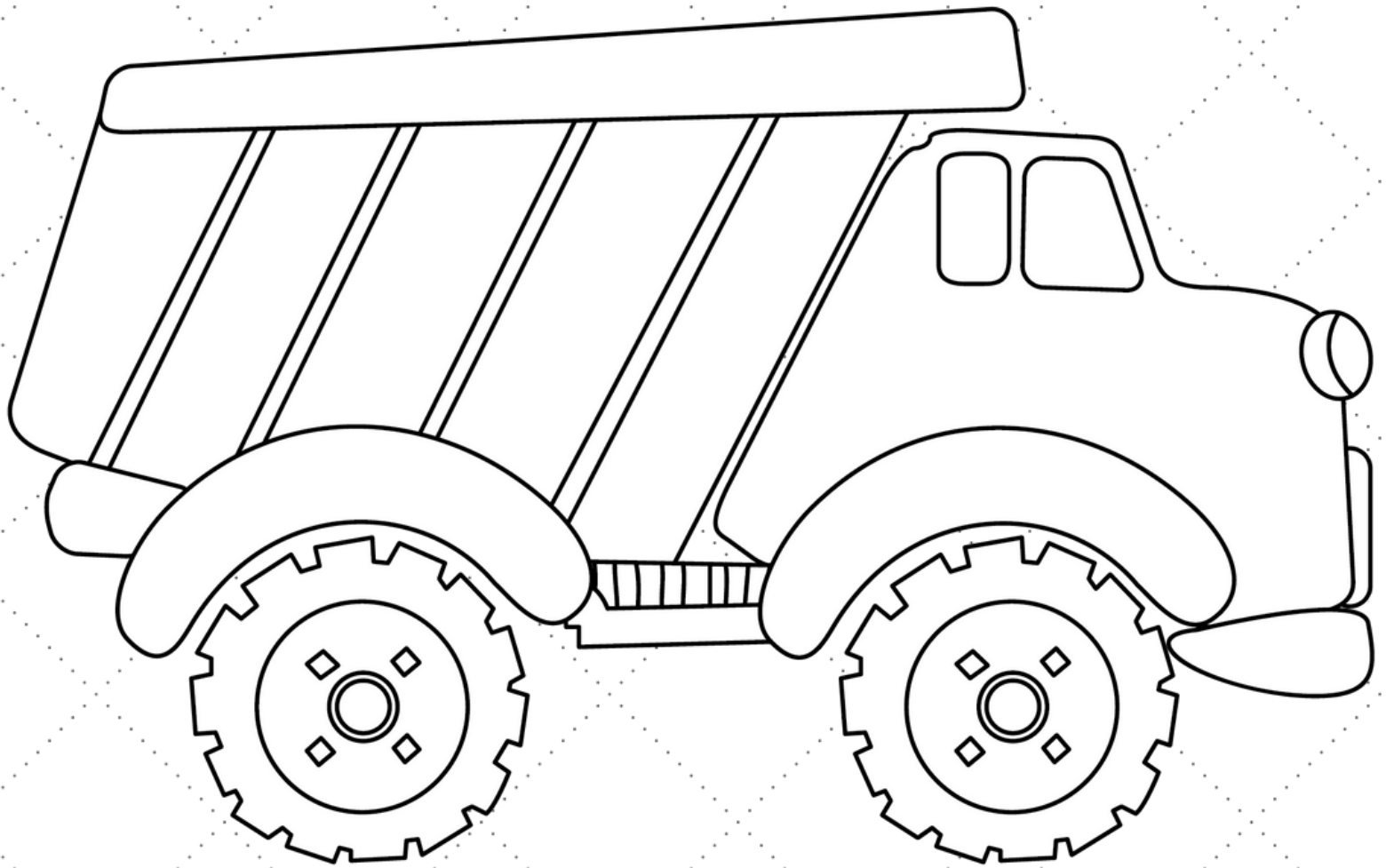

D

is for _____.

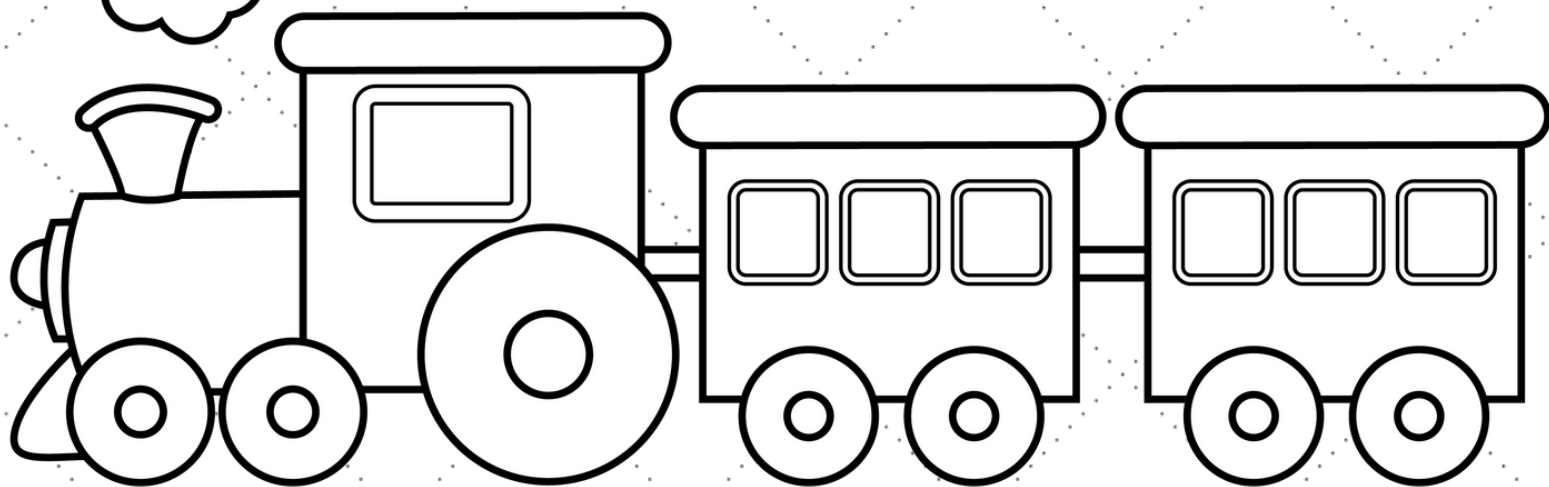
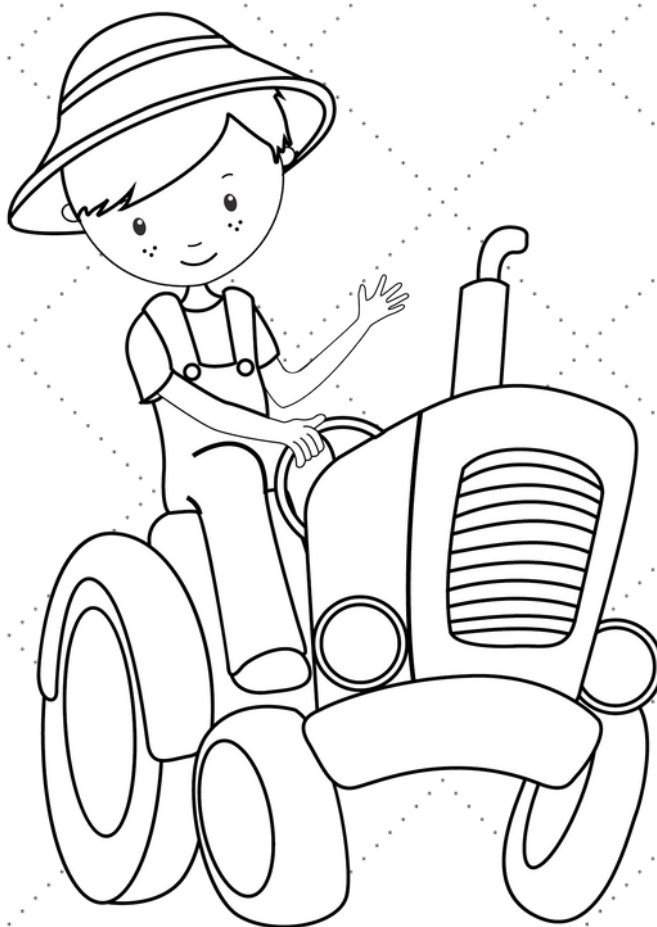

T

is for _____

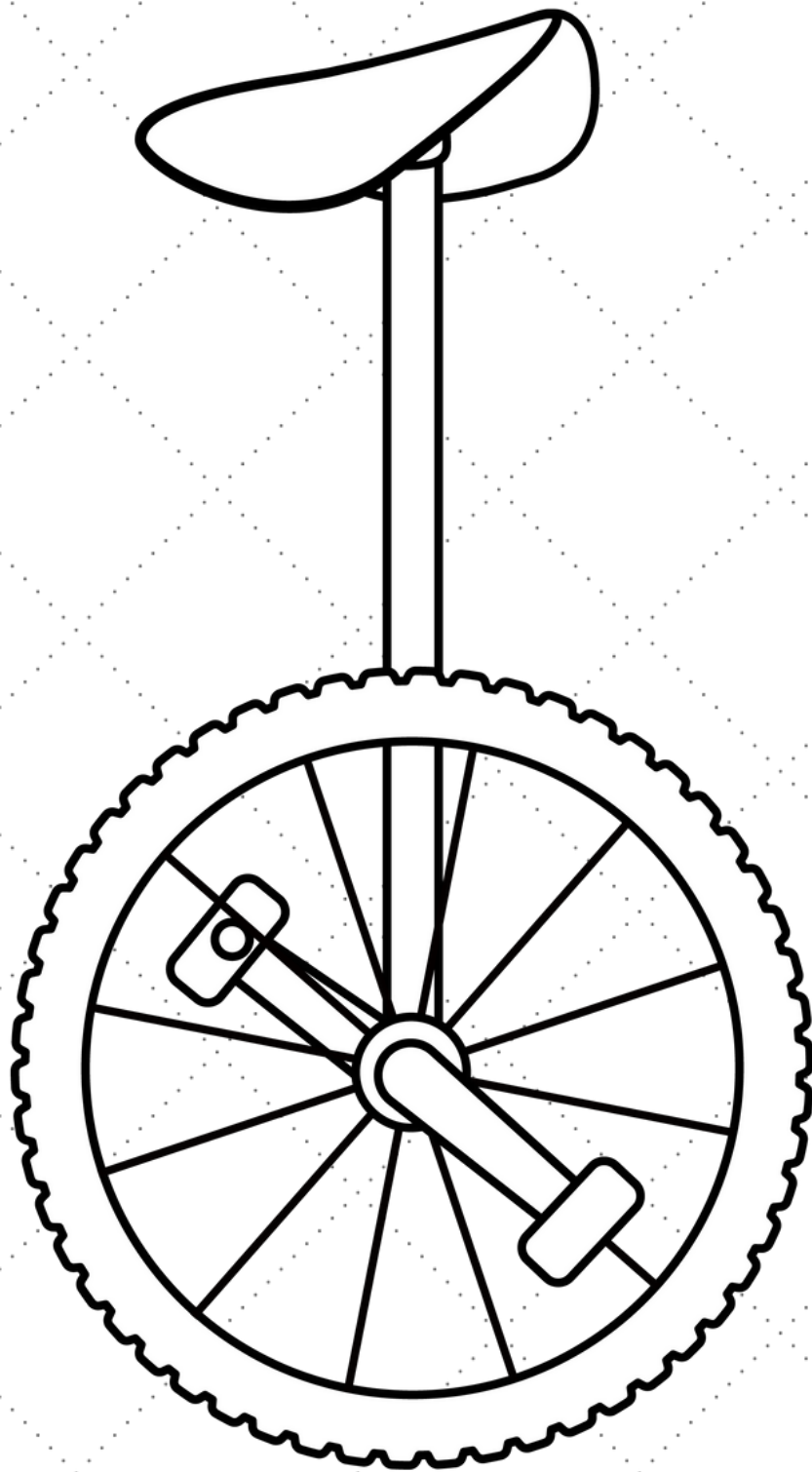

is for _____.

Alphabet Dab - Dot the letter t.

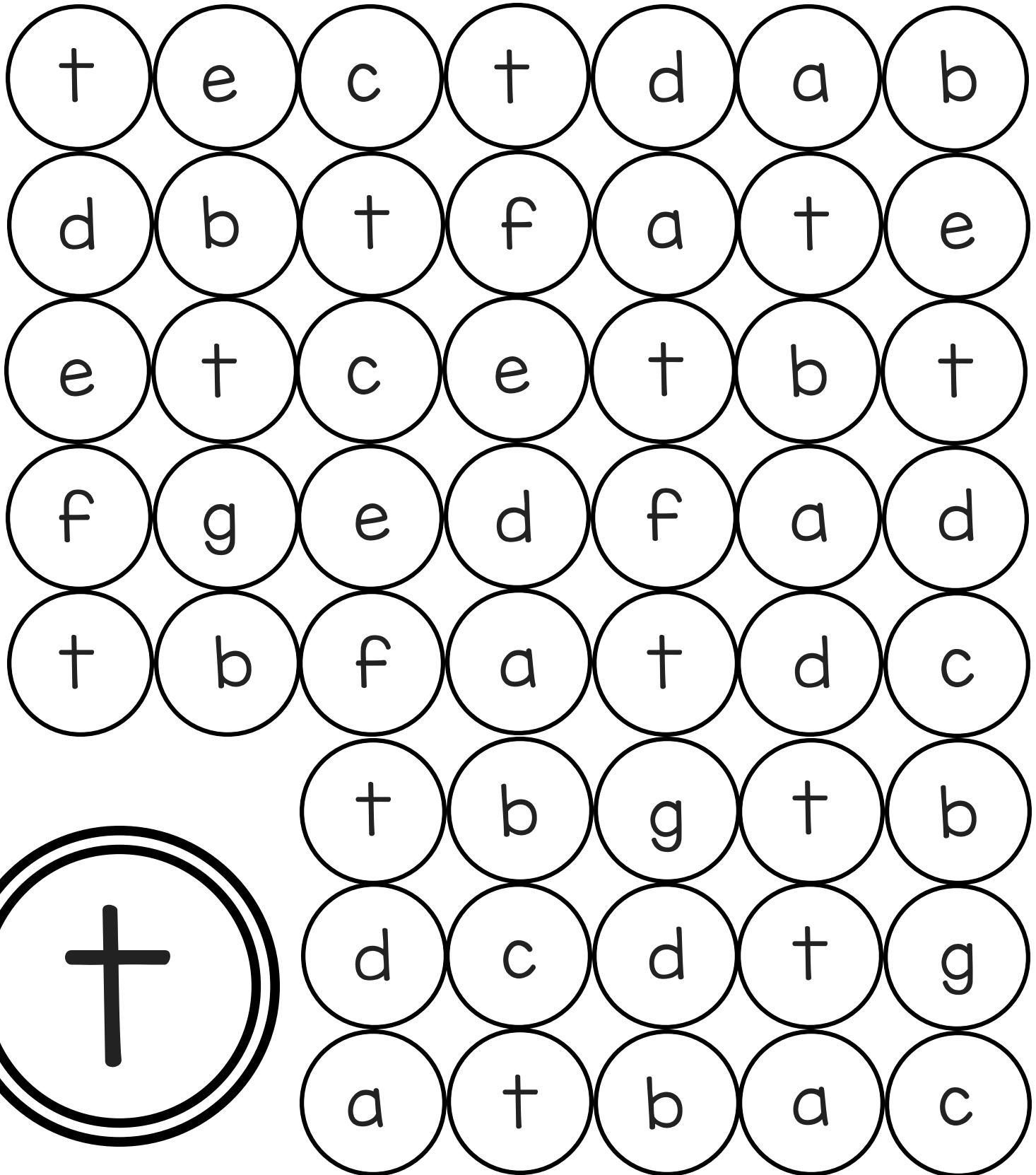

Find the objects that can be used for transportation.



Trace the lines.

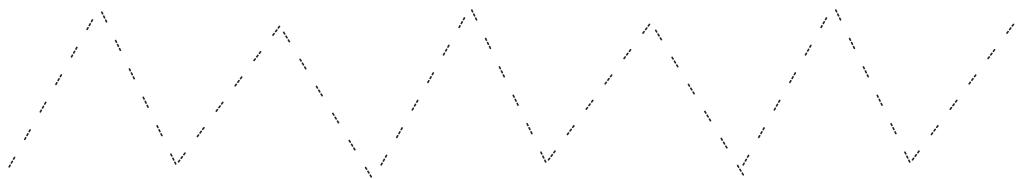
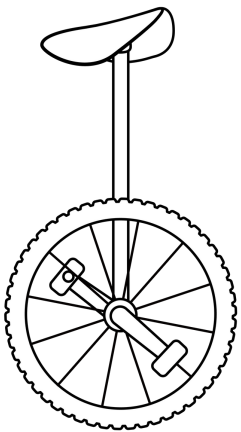
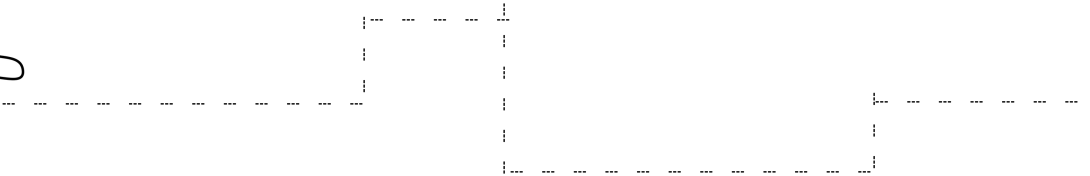
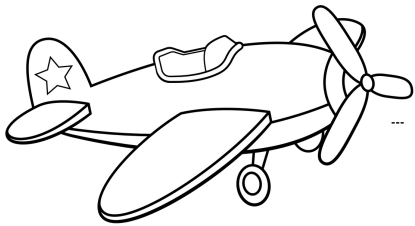
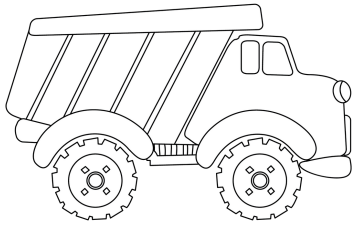
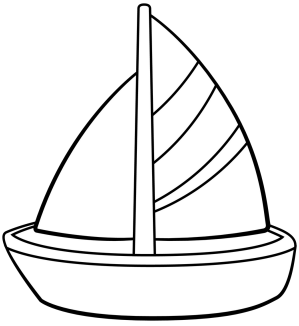

Fancy Shanty®

www.fancysshanty.com

COPYRIGHT / DESIGNERS

PIXELPAPERPRINTS

PRETTYGRAFIKDESIGN